







NO.	DESCRIPTION	QTY
1		3
2		4
3		1
4		1

1

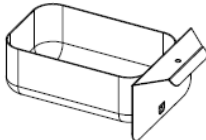
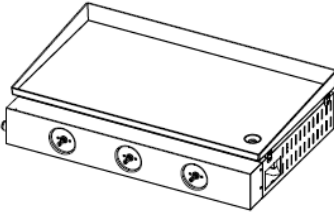
2		4
4		1

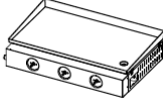
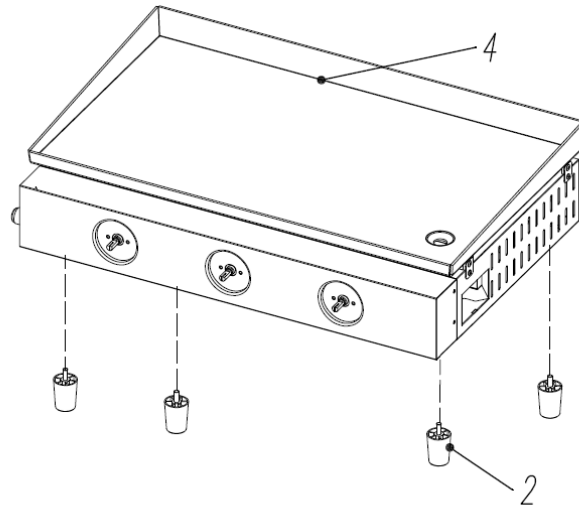

2

3		1
---	---	---

