

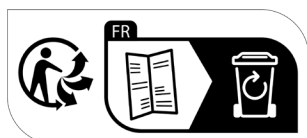

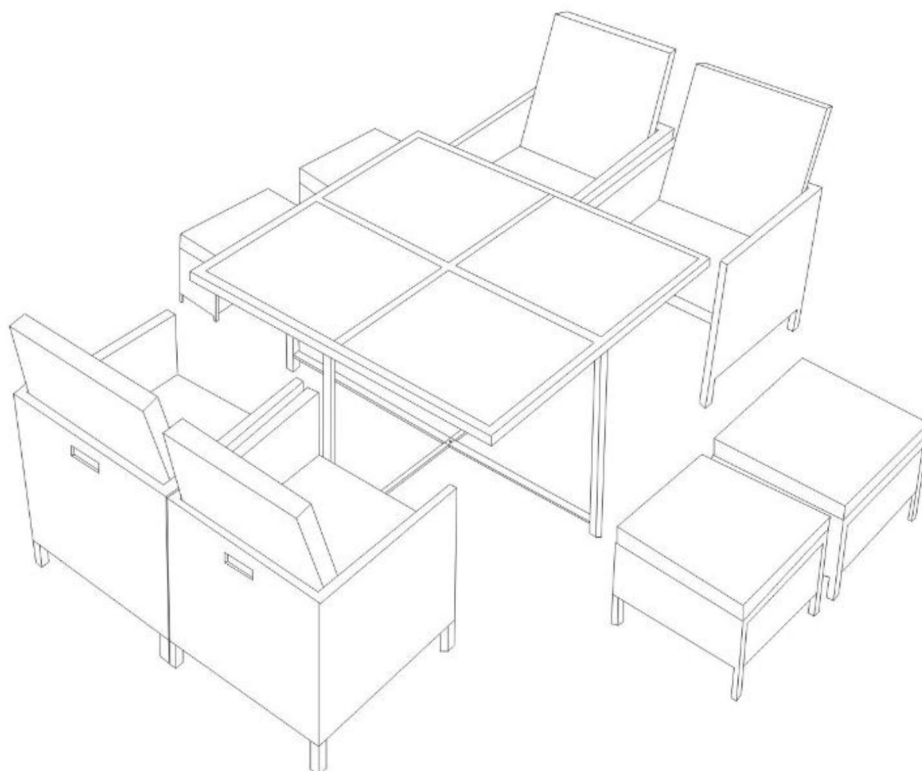

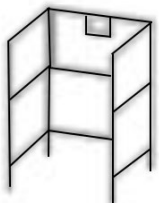

Salon de jardin SANTORIN (910) INSTRUCTIONS D'ASSEMBLAGE

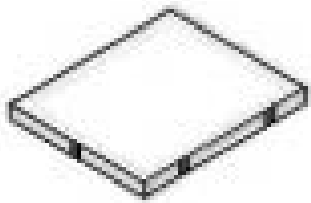
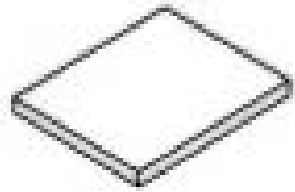

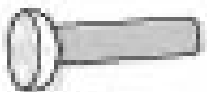
Liste des pièces :

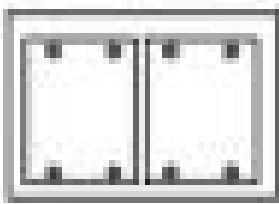
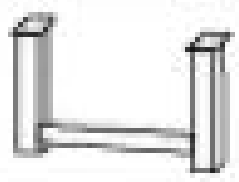
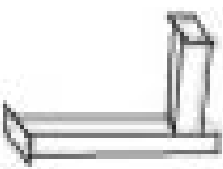
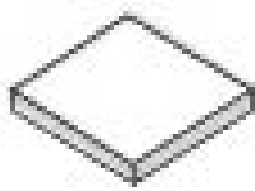
 <p>A - Structures chaise x4</p>	 <p>B - Assises x4</p>	 <p>C - Coussins d'assise x4</p>
 <p>D - Coussins de dossier x4</p>	 <p>E - Vis M6x35 x20</p>	 <p>F - Rondelles x33</p>
 <p>G - Clé BTR x2</p>	 <p>H - Demi-structure x2</p>	 <p>I - Pied x1</p>
 <p>J - Demi-pieds x2</p>	 <p>K - Plateaux x4</p>	 <p>L - Vis M6x15 x8</p>
 <p>M - Vis M6x45 x5</p>	 <p>N - Écrous x5</p>	 <p>O - Clé hexagonale x1</p>

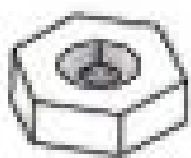
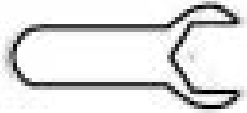
Montage :

Étape A :

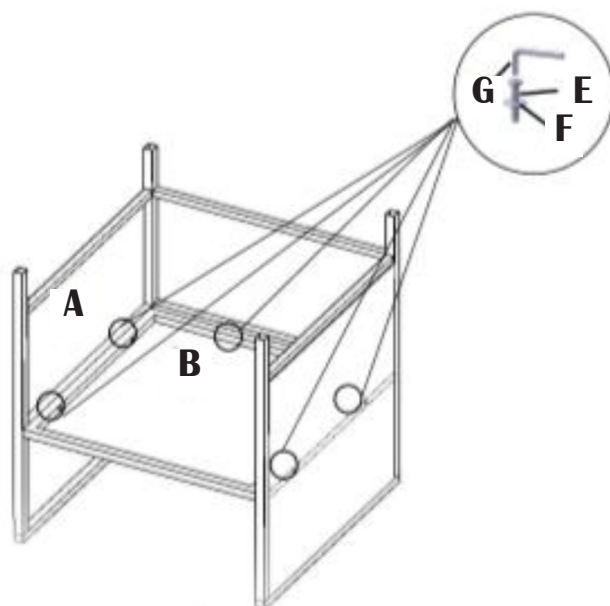

Étape B :

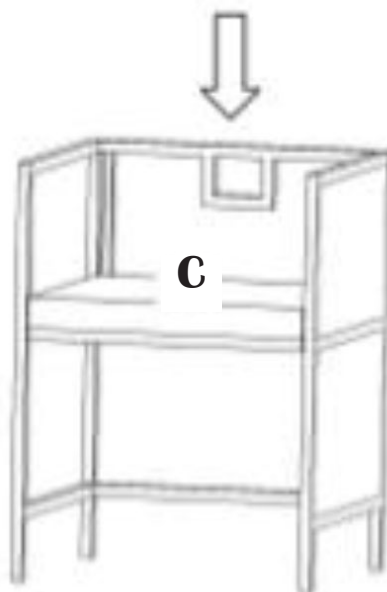

Étape C :

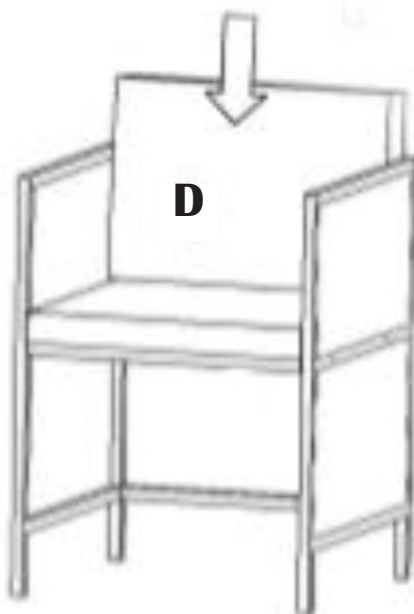

Montage :

Étape D :

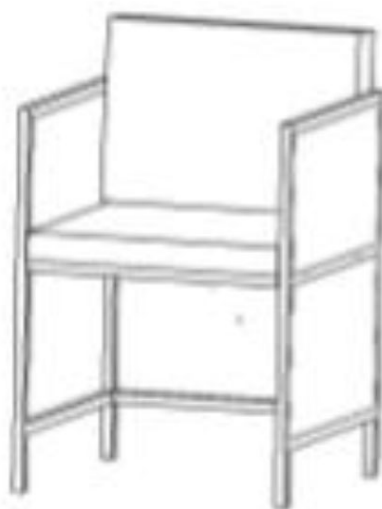

Étape E :

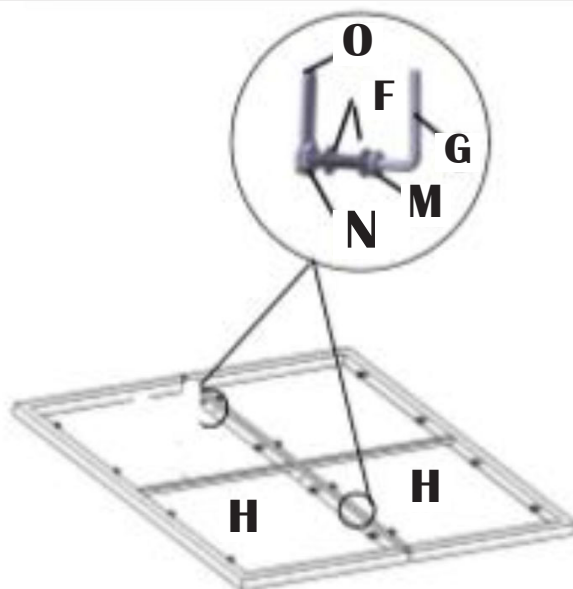

Étape F :

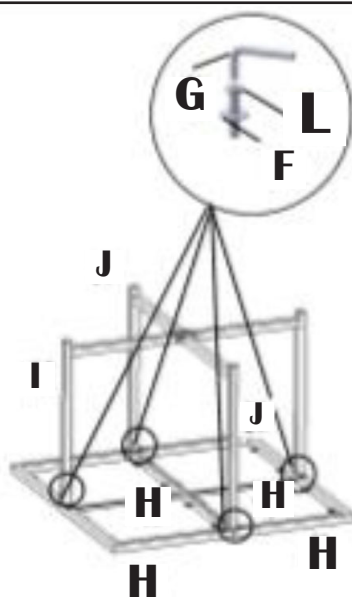

Montage :

Étape G :

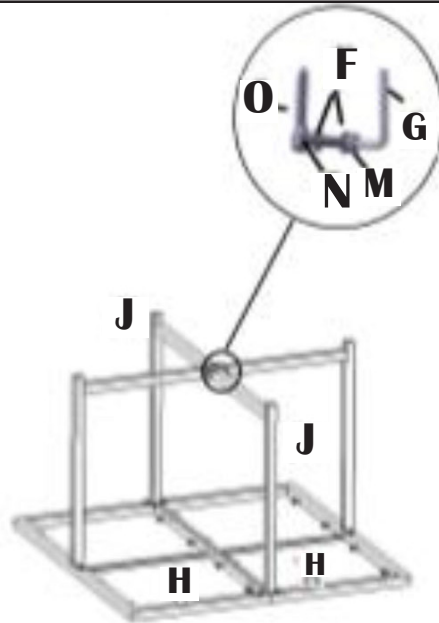

Étape H :

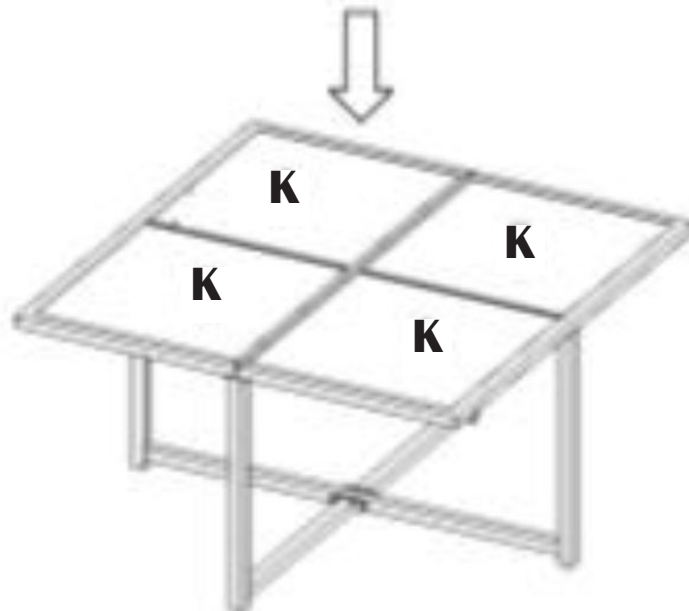

Étape I :



Pour un montage plus facile et rapide, positionner toutes les vis sans serrer complètement puis visser définitivement une fois que toutes les vis sont en place et que l'article est droit.

Informations Complémentaires :

Veillez conserver ce manuel pour référence ultérieure







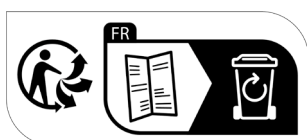
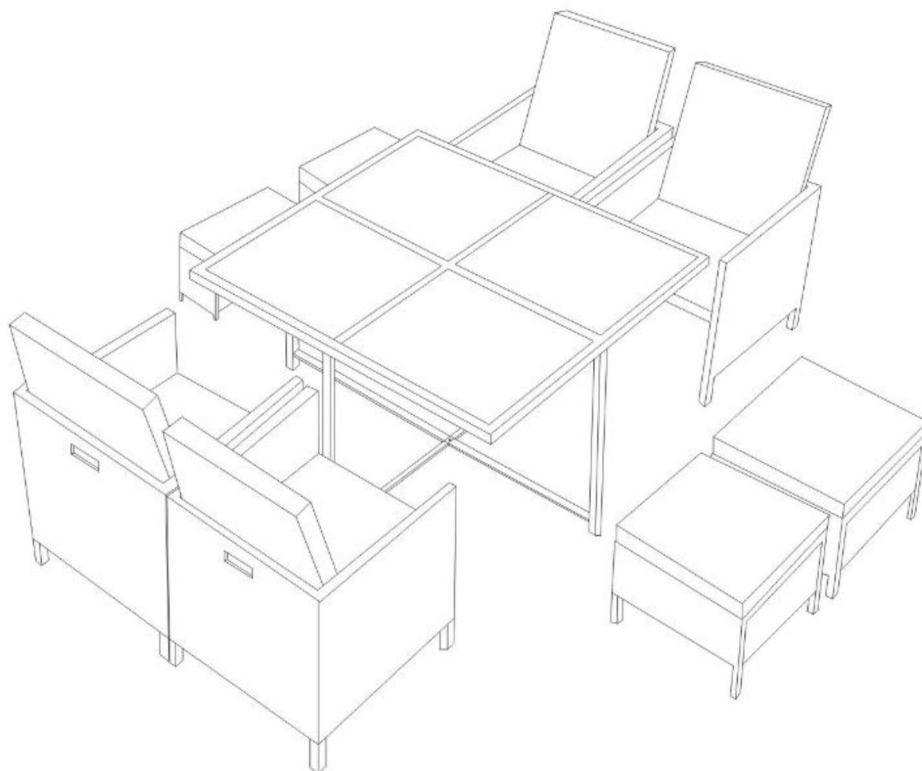

En cas de problème avec votre produit, nous vous invitons à contacter notre service client par mail à contact@happygarden.fr ou par téléphone au +33.3.20.267.567

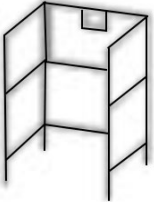
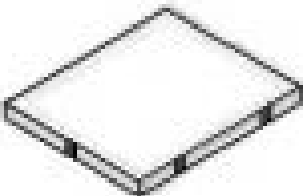
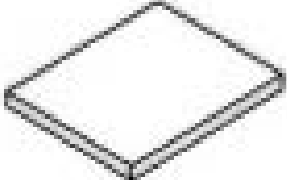
Produit vendu par :
ALLSTORE SAS
236 av. Clément Ader
PA du Moulin
59118 WAMBRECHIES
FRANCE

Conjunto de jardín SANTORIN (910) INSTRUCCIONES DE MONTAJE

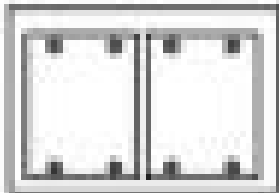
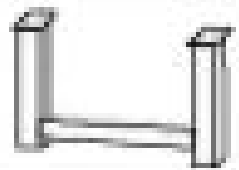
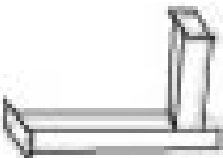
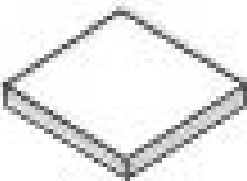

Lista de piezas :

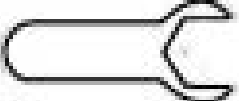
 <p>A - Estructuras sillas x4</p>	 <p>B - Asientos x4</p>	 <p>C - Cojines asientos x4</p>
 <p>D - Cojines respaldos x4</p>	 <p>E - Tornillos M6x35 x20</p>	 <p>F - Arandelas x33</p>
 <p>G - Llave BTR x2</p>	 <p>H - Media estructuras x2</p>	 <p>I - Patas x1</p>
 <p>J - Media patas x2</p>	 <p>K - Tablero x4</p>	 <p>L - Tornillos M6x15 x8</p>
 <p>M - Tornillos M6x45 x5</p>	 <p>N - Tuercas x5</p>	 <p>O - Llave hexagonal x1</p>

Montaje :

Etapa A :

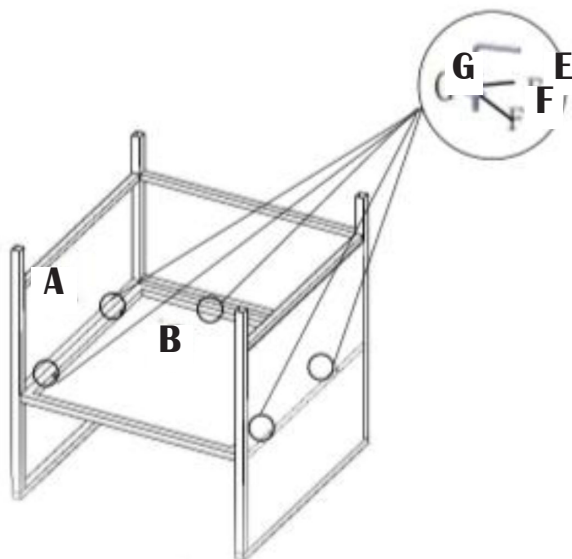

Etapa B :

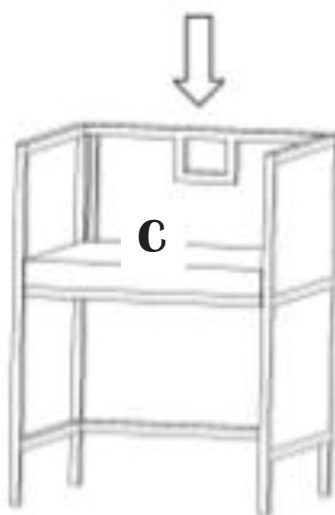

Etapa C :

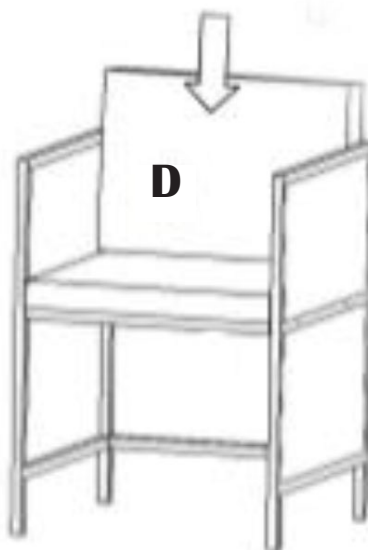

Montaje :

Etapa D :

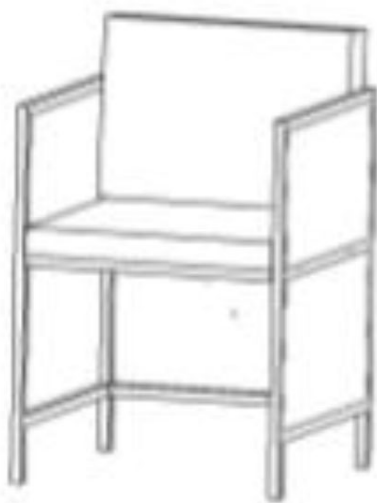

Etapa E :

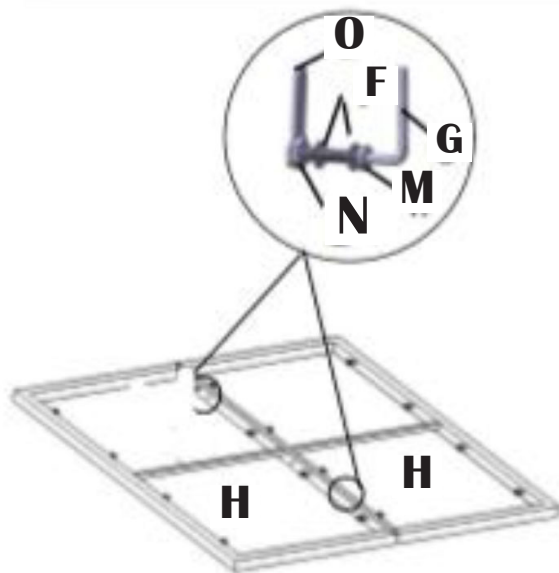

Etapa F :

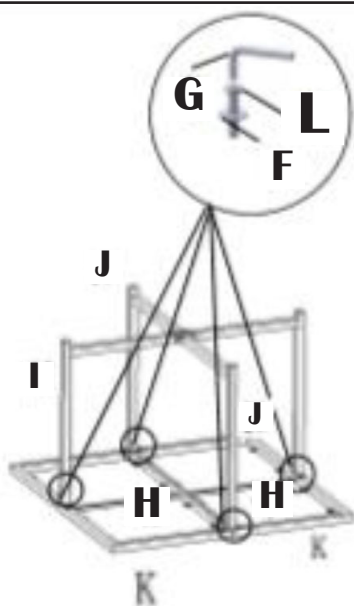

Montaje :

Etapa G :

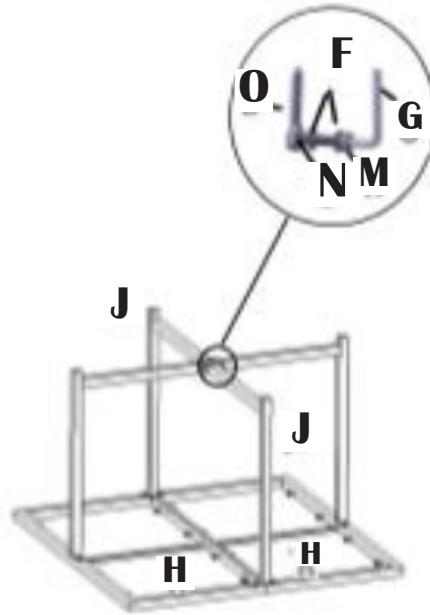

Etapa H :

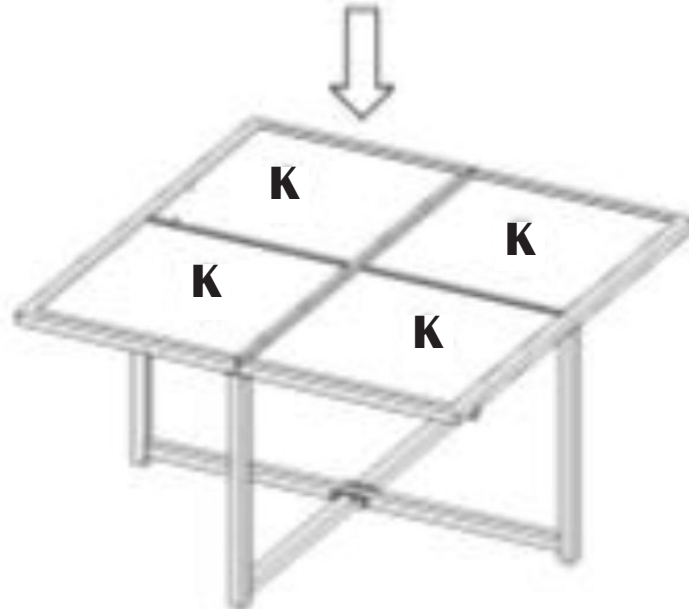

Etapa I :



Para un montaje más fácil y rápido: Coloque todos los tornillos sin apretar completamente y luego atornille definitivamente una vez que todos los tornillos estén en su lugar y que el artículo esté bien recto.

Información Adicional :

Le rogamos conserve este manual de instrucciones para futuras consultas

Si encuentra algún problema con su producto, le solicitamos que contacte con nuestro servicio de atención al cliente por correo electrónico: spv@happy-garden.es o por teléfono al 919 035 926

Producto vendido por :
ALLSTORE SAS