

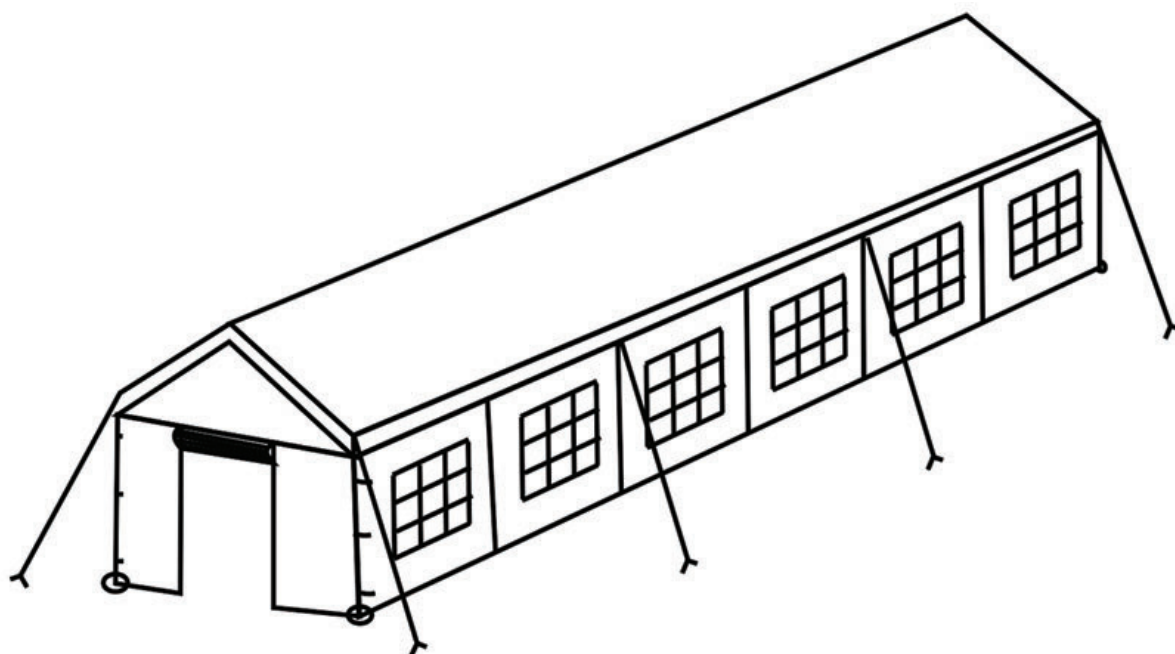

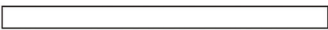





Tente de réception ZONDA 6x12m (2TEN106) INSTRUCTIONS D'ASSEMBLAGE

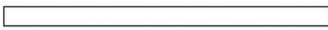

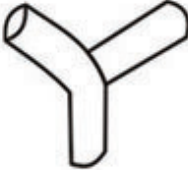
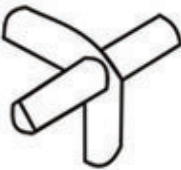
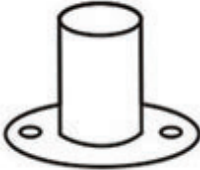
Liste des pièces :

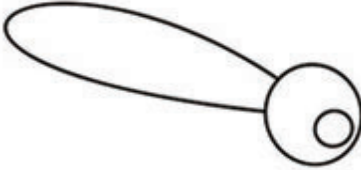
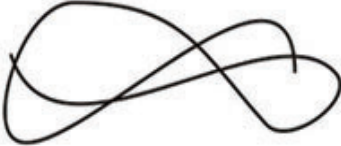
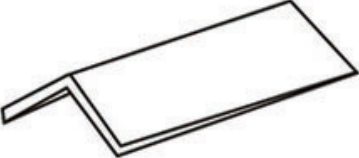
 <p>A - Tubes x14</p>	 <p>B - Tubes x14</p>	 <p>C - Tubes x18</p>
 <p>D - Tubes x14</p>	 <p>E - Croisillons latéraux x6</p>	 <p>F - Croisillons centraux x15</p>
 <p>G - Pieds x14</p>	 <p>H - Sardines x36</p>	 <p>I - Cordons x84</p>
 <p>J - Fils x8</p>	 <p>K - Toile de toit x1</p>	 <p>L - Toile latérales x2</p>
 <p>M - Portes x2</p>		

Montage :

Étape A :

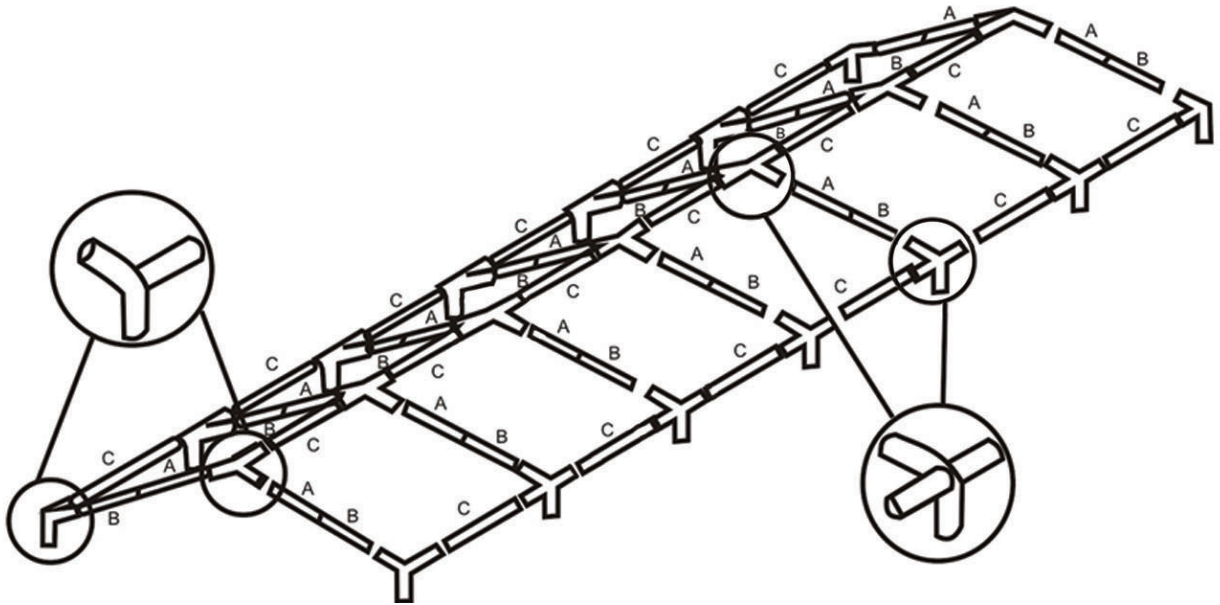

Étape B :

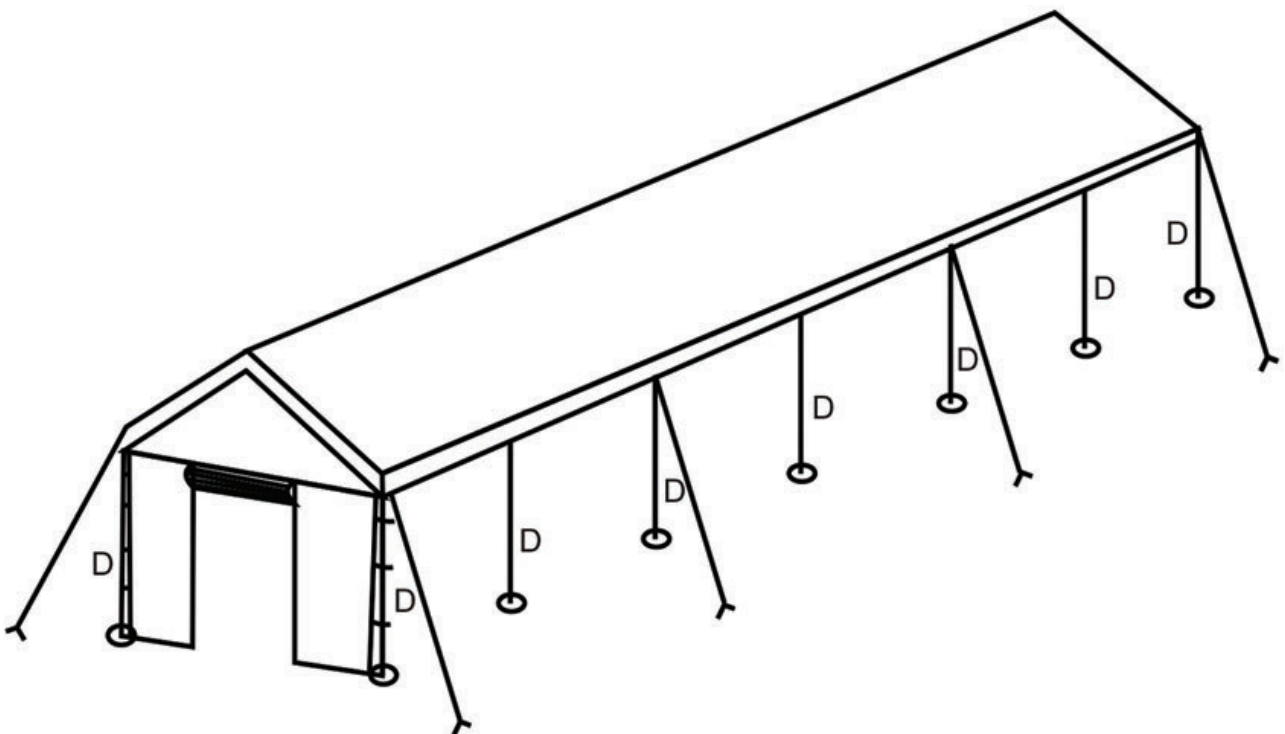

Montage :

Étape C :

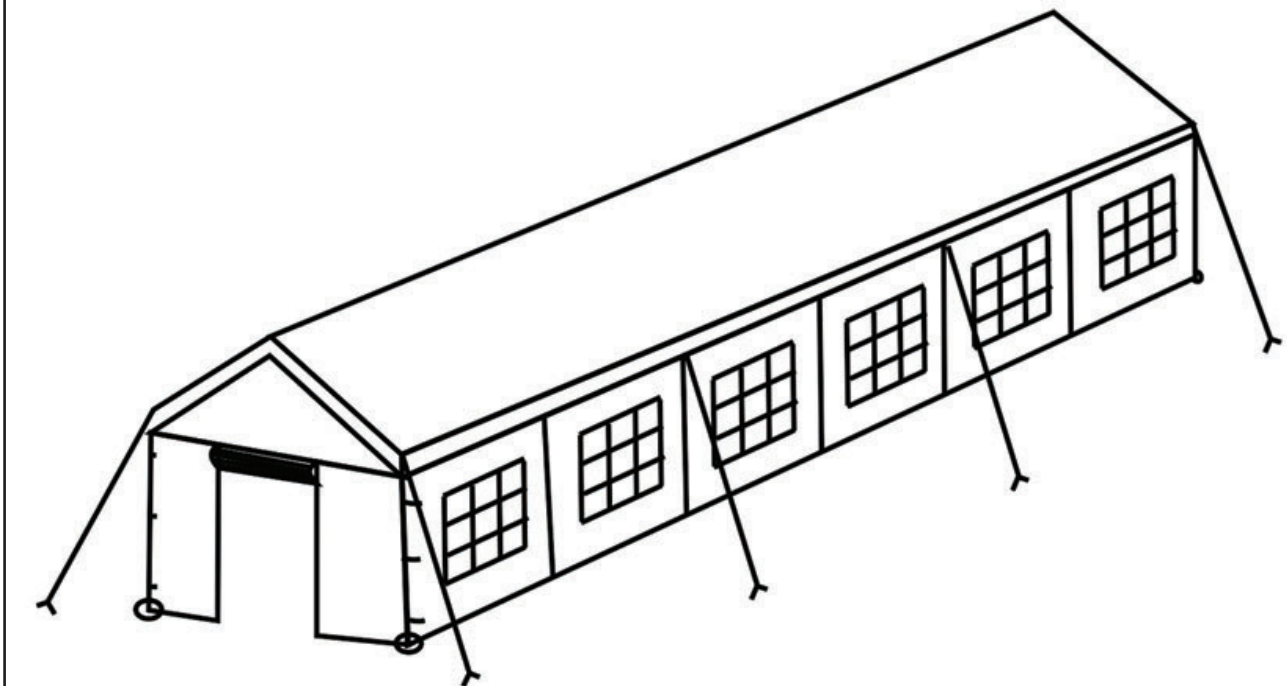

Informations Complémentaires :

Veillez conserver ce manuel pour référence ultérieure





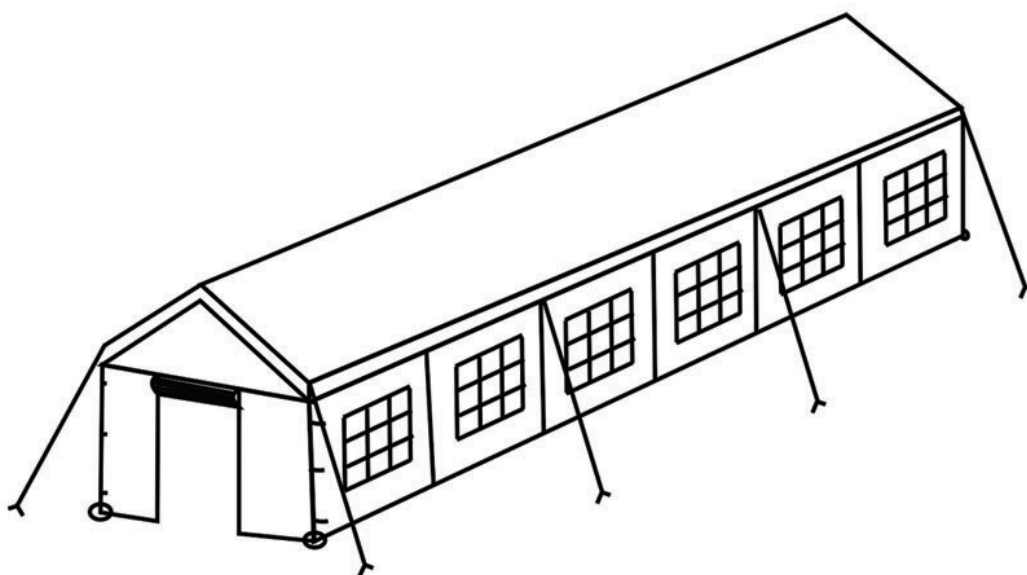

En cas de problème avec votre produit, nous vous invitons à contacter notre service client par mail à contact@happygarden.fr ou par téléphone au +33.3.20.267.567

Produit vendu par :
ALLSTORE SAS
236 av. Clément Ader
PA du Moulin
59118 WAMBRECHIES
FRANCE

Carpa de recepción ZONDA 6X12M (2TEN106) INSTRUCCIONES DE MONTAJE

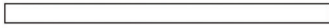

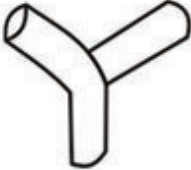
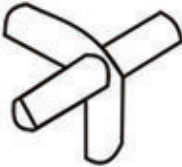
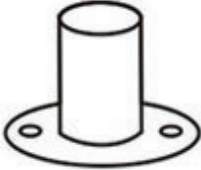
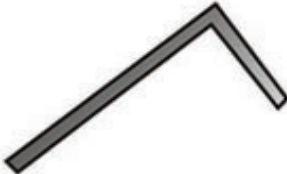
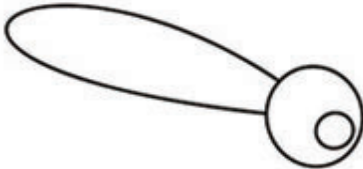
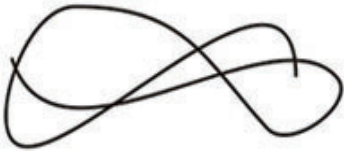
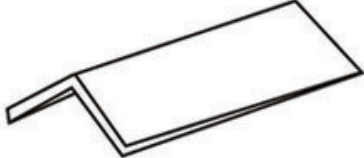
Lista de piezas :

 <p>A - Tubos x14</p>	 <p>B - Tubos x14</p>	 <p>C - Tubos x18</p>
 <p>D - Tubos x14</p>	 <p>E - Travesaños laterales x6</p>	 <p>F - Travesaños centrales x15</p>
 <p>G - Patas x14</p>	 <p>H - Estacas x36</p>	 <p>I - Cordones x84</p>
 <p>J - Hilos x8</p>	 <p>K - Lona x1</p>	 <p>L - Lona laterales x2</p>
 <p>M - Puertas x2</p>		

Montaje :

Etapa A :

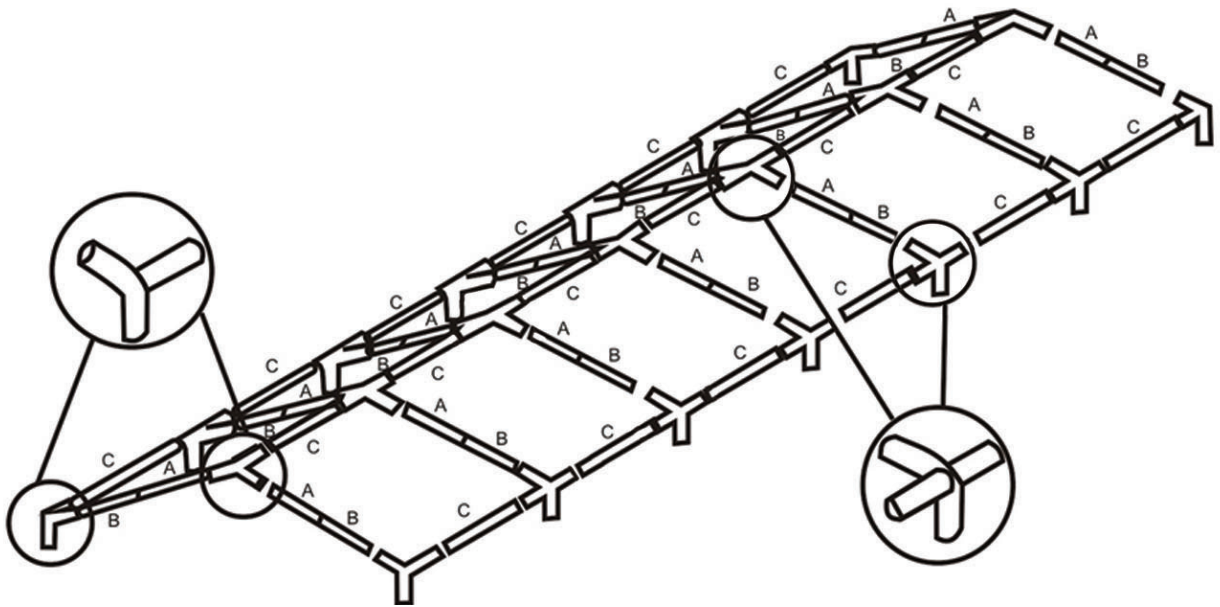

Etapa B :

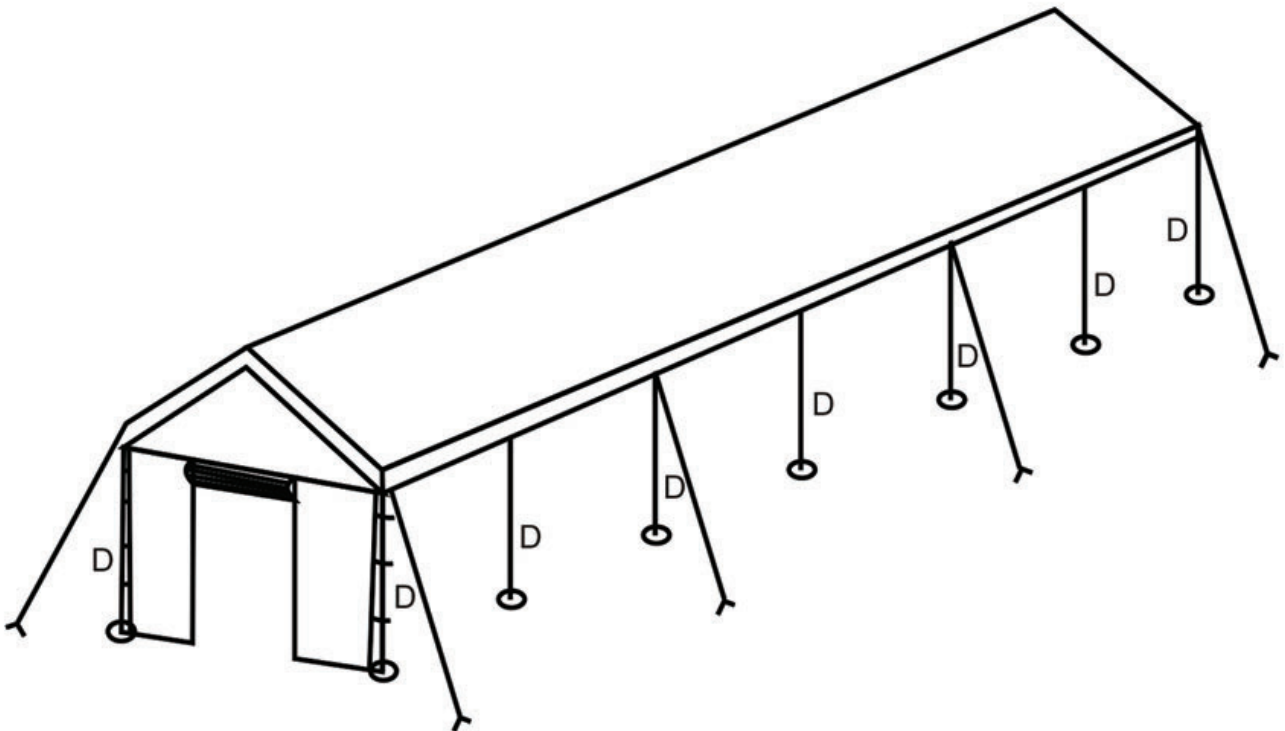

Montaje :

Etapa C :

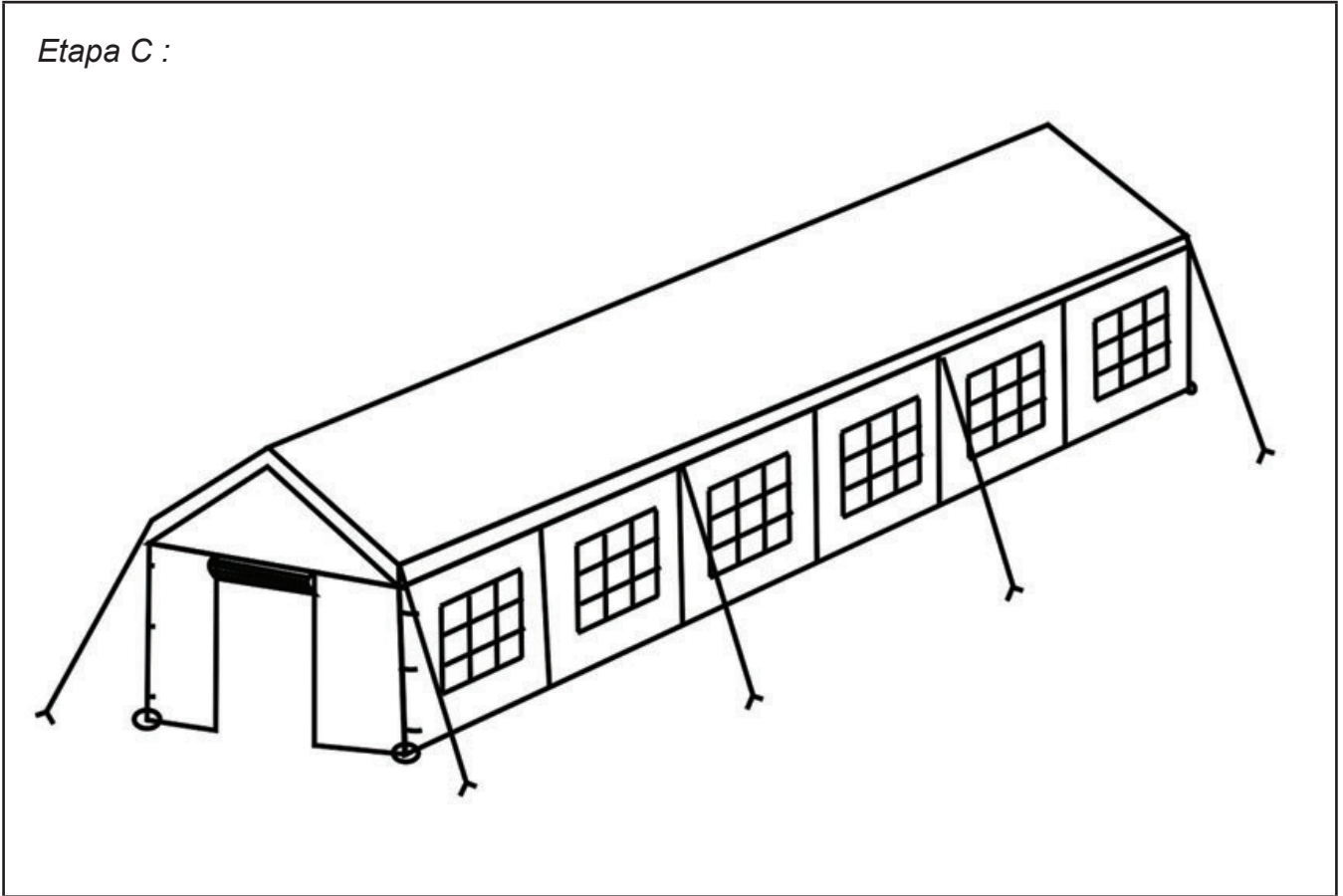

Información Adicional :

Le rogamos conserve este manual de instrucciones para futuras consultas

Si encuentra algún problema con su producto, le solicitamos que contacte con nuestro servicio de atención al cliente por correo electrónico: spv@happy-garden.es o por teléfono al 919 035 926

Producto vendido por :
ALLSTORE SAS