

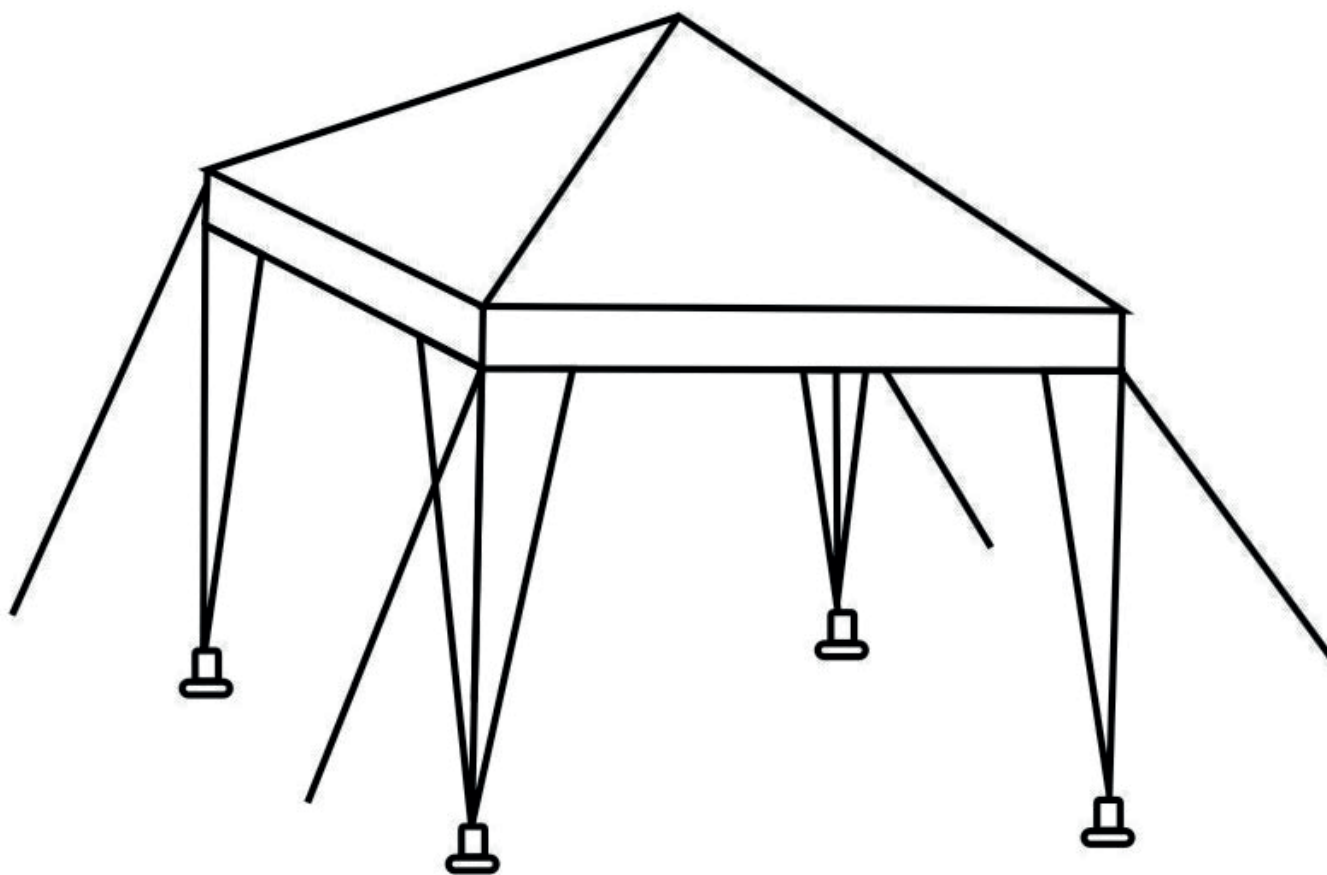









Tente de réception 3×3m TRAMONTANE(2TEN100) INSTRUCTIONS D'ASSEMBLAGE

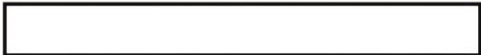

Liste des pièces :

 <p>1 - Tubes ×4</p>	 <p>2 - Tubes ×4</p>
 <p>3 - Tubes ×8</p>	 <p>4 - Tubes ×4</p>
 <p>5 - Tubes ×4</p>	 <p>6 - Tubes ×4</p>
 <p>A- Croisillon (sommets) ×1</p>	 <p>B- Croisillons (coins) ×4</p>
 <p>C- Pieds ×4</p>	 <p>D- Sardines ×8</p>
 <p>E- Fils ×4</p>	

Montage :

Étape A :

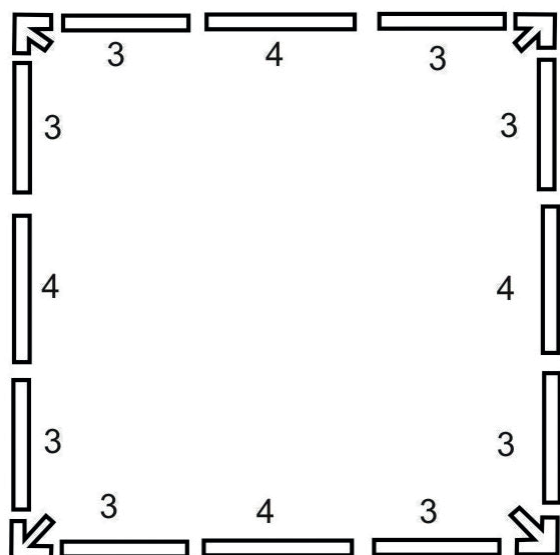

Étape B :

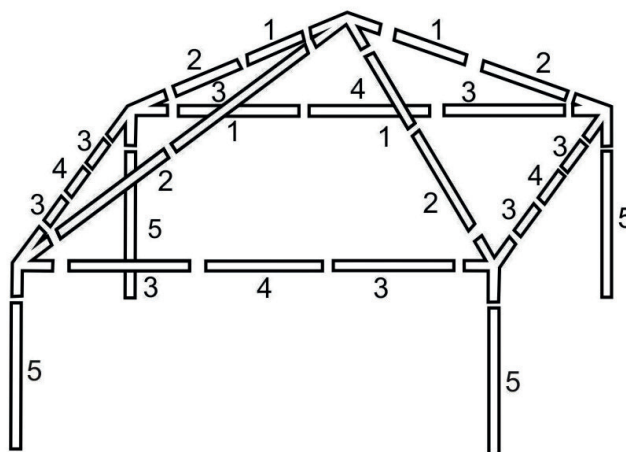

Étape C :

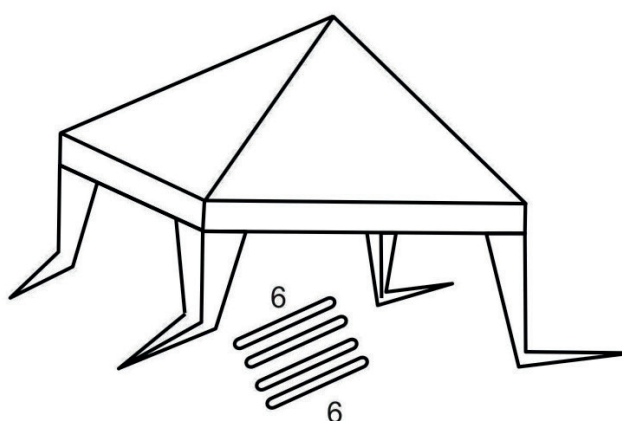

Étape D :

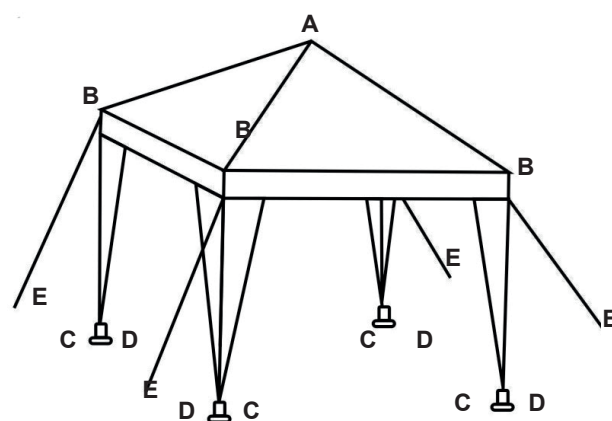

Attention : cet article n'est pas une structure permanente.
Démonter et stocker dans un endroit sec en cas d'intempéries (fort vent, orage, tempête, etc...)

Informations Complémentaires :

Veillez conserver ce manuel pour référence ultérieure





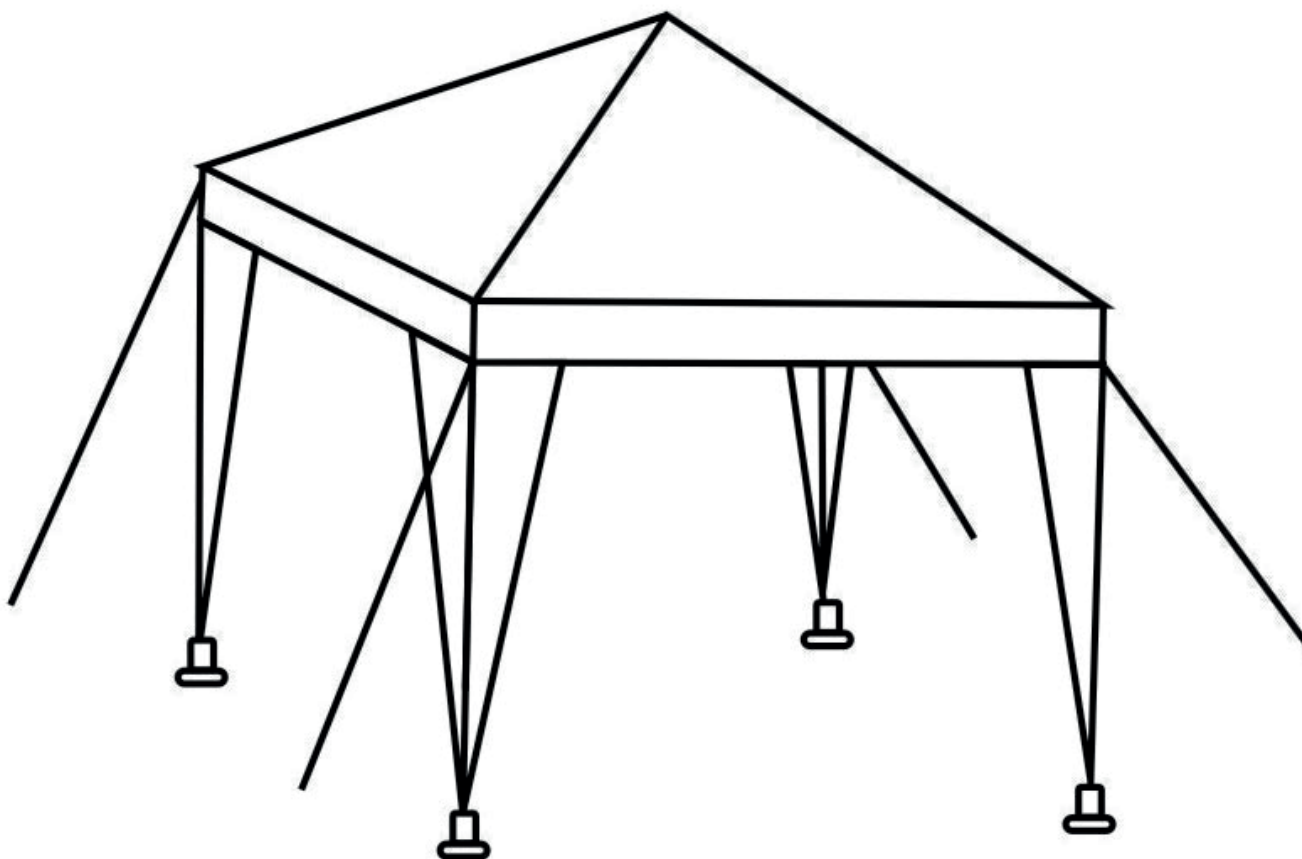

En cas de problème avec votre produit, nous vous invitons à contacter notre service client par mail à contact@happygarden.fr ou par téléphone au +33.3.20.267.567

Produit vendu par :
ALLSTORE SAS
236 av. Clément Ader
PA du Moulin
59118 WAMBRECHIES
FRANCE

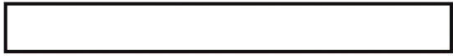
Carpa para eventos 3x3m TRAMONTANE(2TEN100) INSTRUCCIONES DE MONTAJE

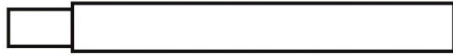
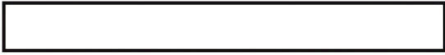
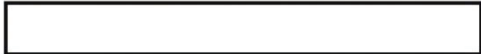

Lista de piezas :

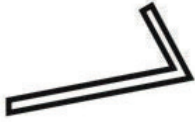
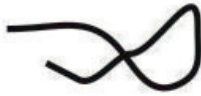
 <p>1 - Tubos ×4</p>	 <p>2 - Tubos ×4</p>
 <p>3 - Tubos ×8</p>	 <p>4 - Tubos ×4</p>
 <p>5 - Tubos ×4</p>	 <p>6 - Tubos ×4</p>
 <p>A- Travesaño (punta) ×1</p>	 <p>B- Travesaños (esquinas) ×4</p>
 <p>C- Patas ×4</p>	 <p>D- Estacas ×8</p>
 <p>E- Hilos ×4</p>	

Montaje :

Etapa A :

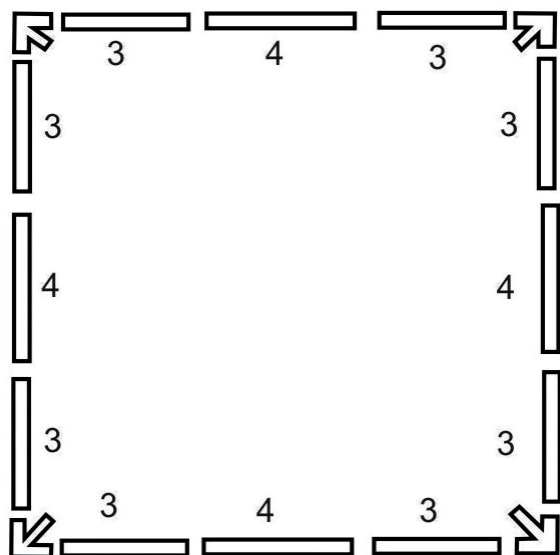

Etapa B :

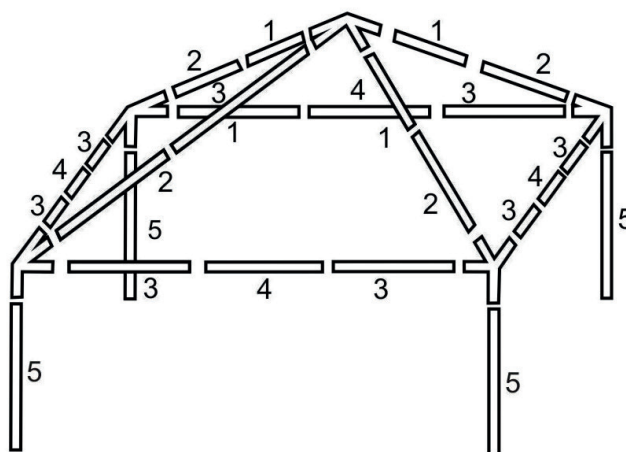

Etapa C :

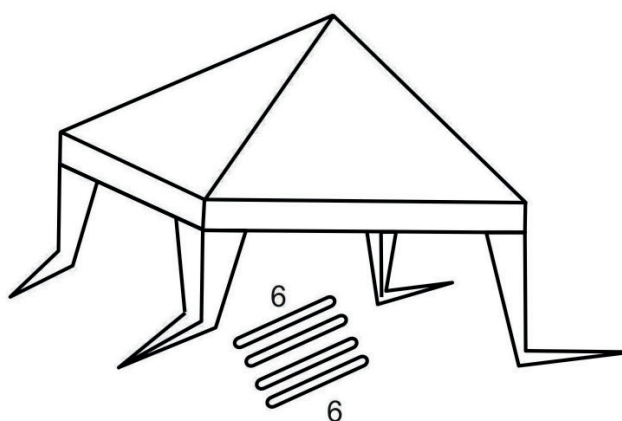

Etapa D :

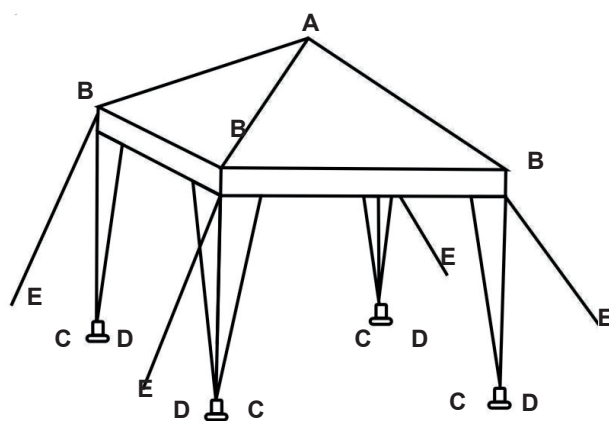

¡Cuidado! : Este artículo no es una estructura permanente.
Desmontar y guardar en un lugar seco en caso de mal tiempo (fuerte viento, tormenta, etc...)

Información adicional :

Le rogamos conserve este manual de instrucciones para futuras consultas

Si encuentra algún problema con su producto, le solicitamos que contacte con nuestro servicio de atención al cliente por correo electrónico: contacto@happy-garden.es o por teléfono al 919 035 926

Producto vendido por :
ALLSTORE SAS